

Technische Daten:
Stützpfeiler-Set Boden/Decke für Walk-in Dusche - Sabia

Datasheet:
Support post set floor/ceiling for walk-in shower - Sabia

Art. 77403201270-20
Art. 77403201270-23
Art. 77403201270-26

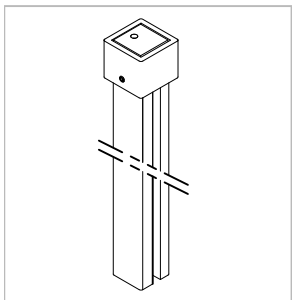

Ausführung: 8 mm Keine Glasbohrungen nötig
Options: NO glass-machining needed

Material:	V2A	Gewicht: / Weight: 2,7 kg		
Material:	Stainless steel AISI 304			
Oberflächen:	Edelstahl-Design	Chrom-Design	Anthrazit-Design	
Finish:	Stainless steel design	Chrom-Design	Anthracite design	

Umfang der Lieferung
Scope of Supply:

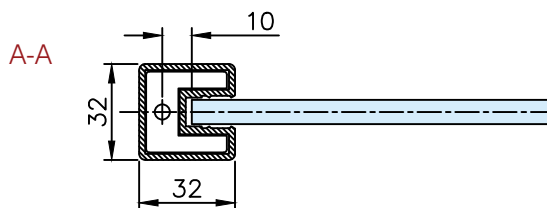
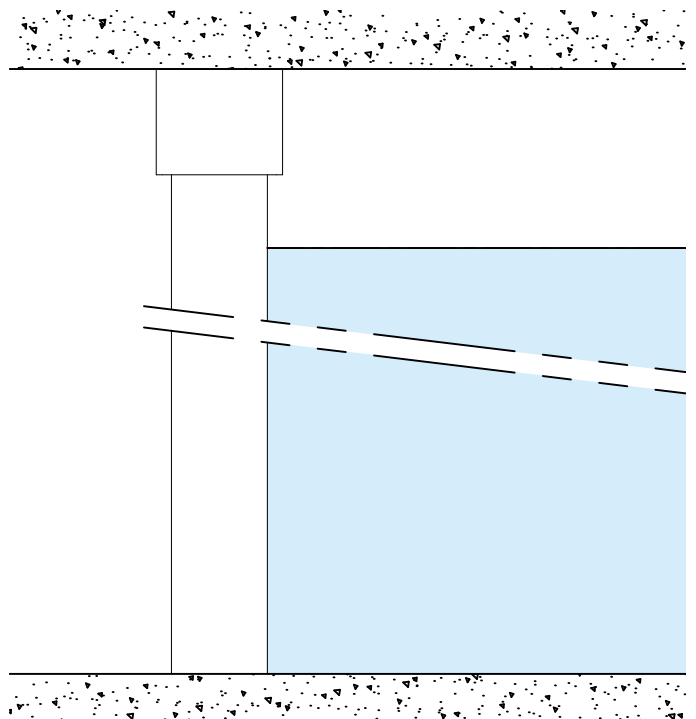
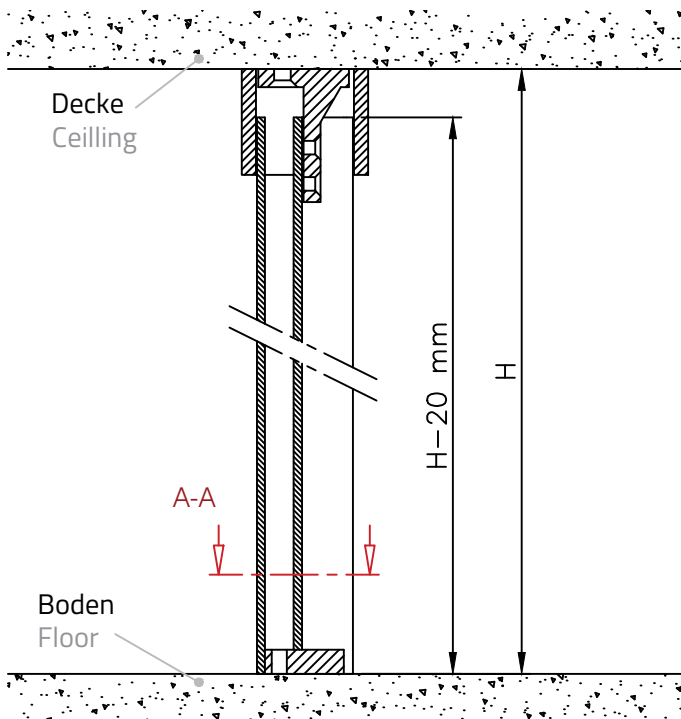
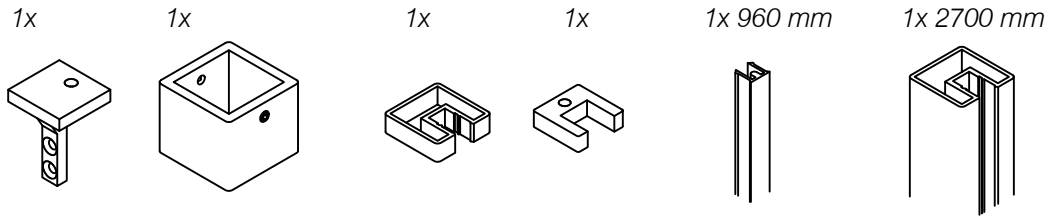

Art. 77403201270-20
Art. 77403201270-23
Art. 77403201270-26

Stand 10.2023

Zusammenbau:
Assembly:

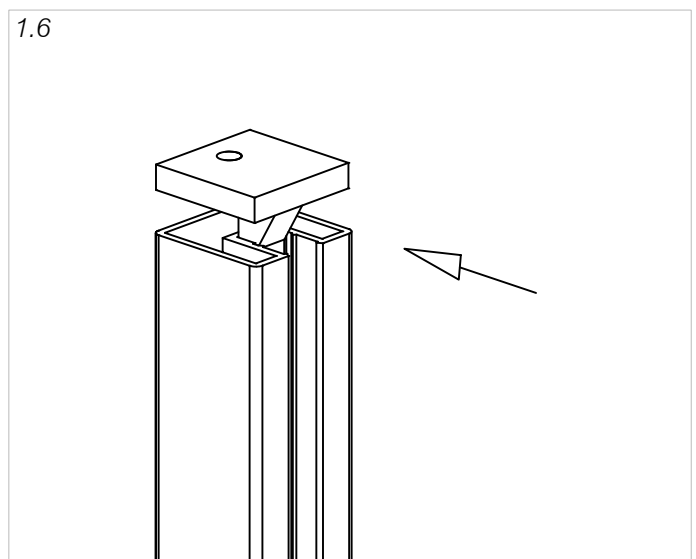
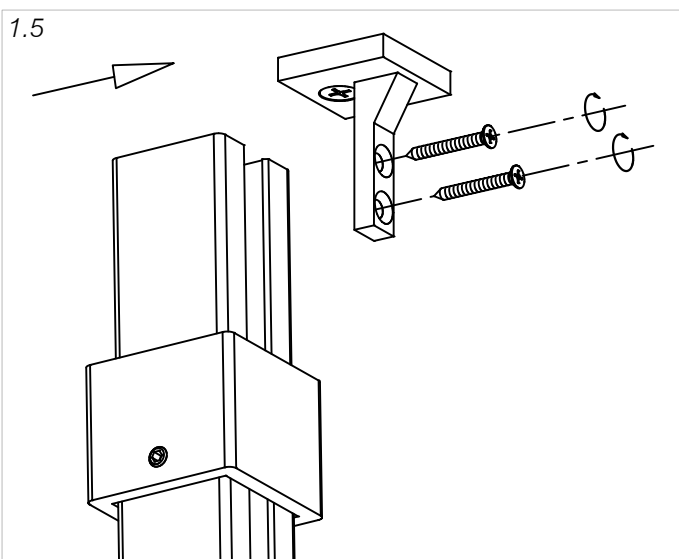
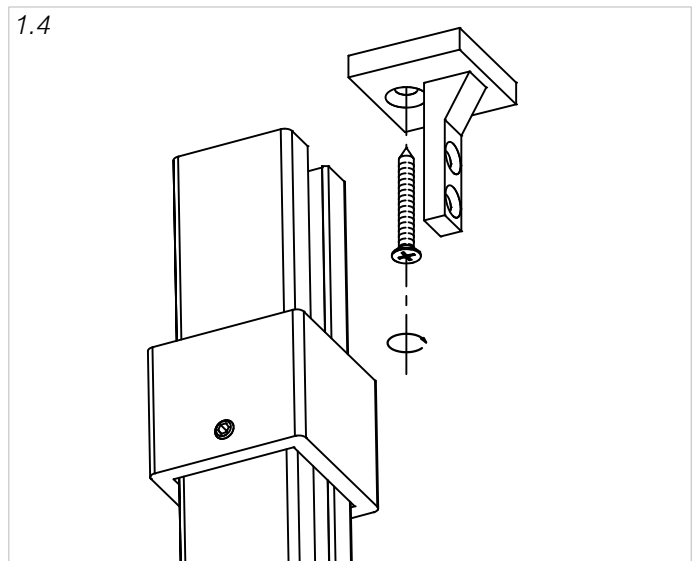
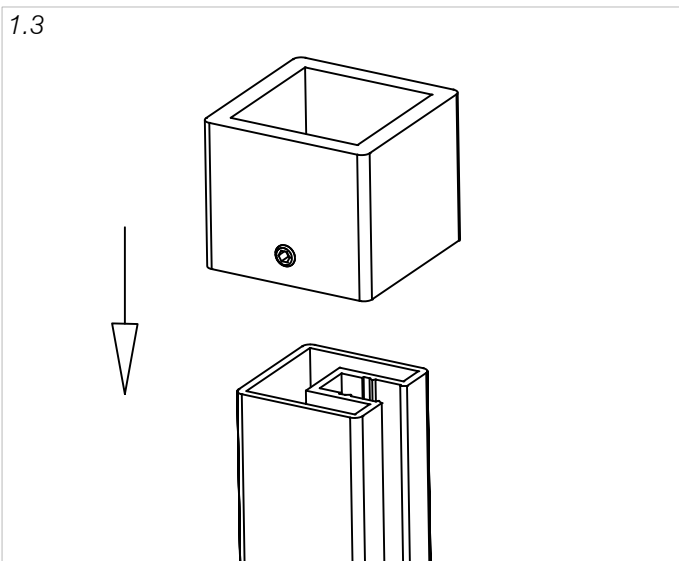
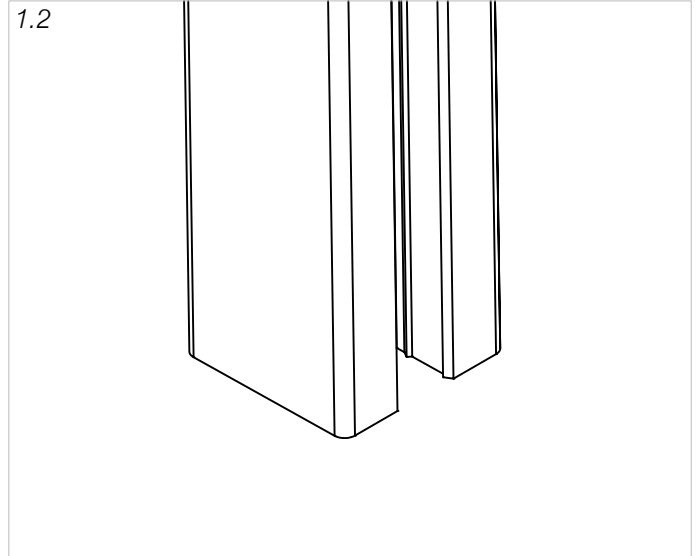
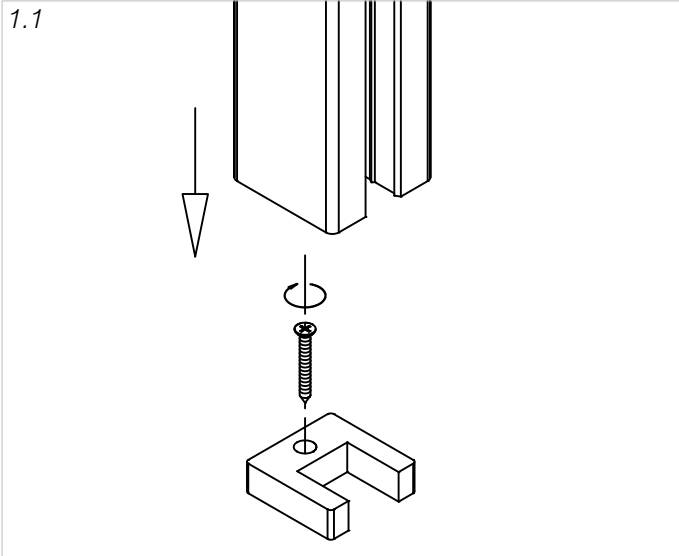

Art. 77403201270-20
Art. 77403201270-23
Art. 77403201270-26

Stand 10.2023

Zusammenbau:
Assembly:

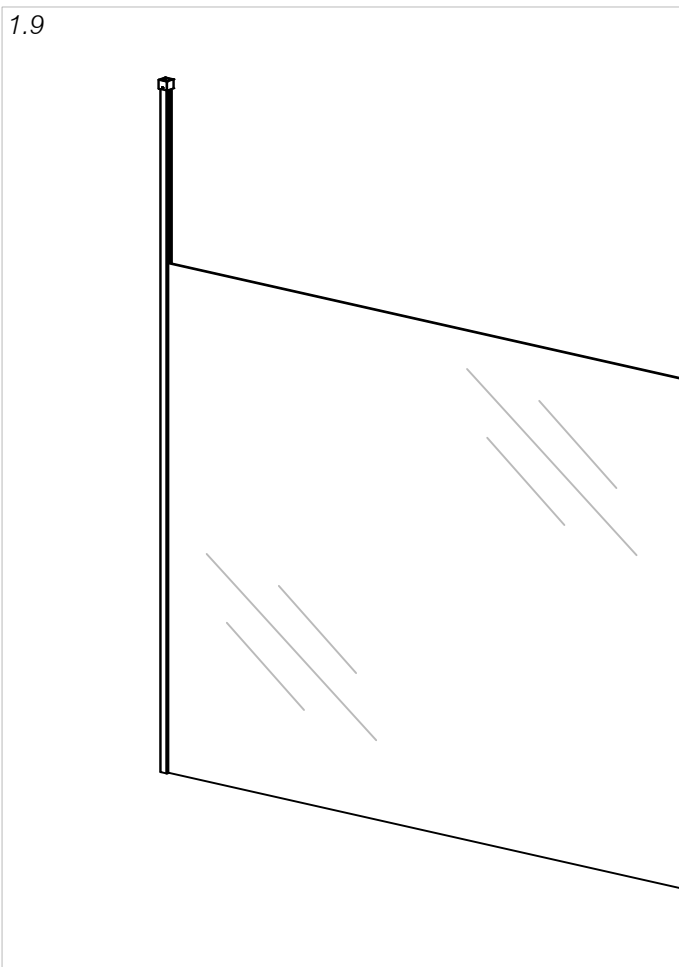
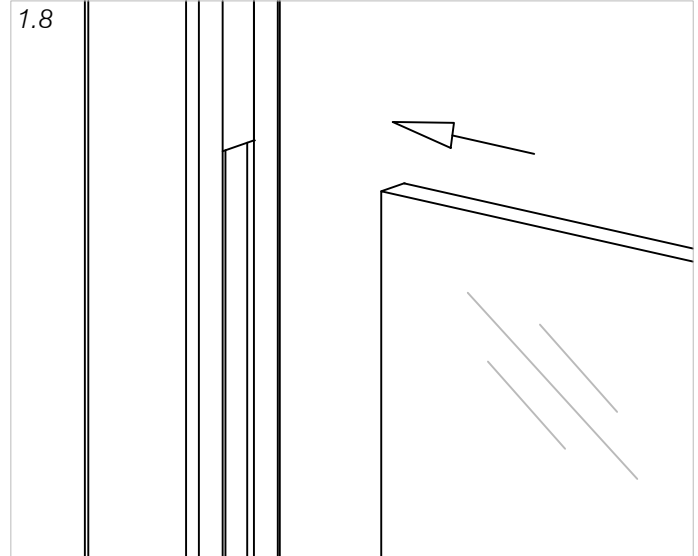
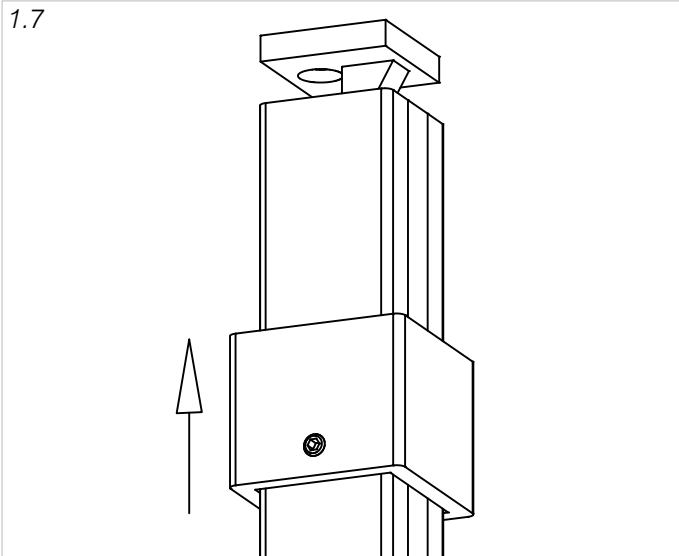

G-FITTINGS GmbH

Marie-Curie-Straße 16-18
46446 Emmerich am Rhein
T +49 (0)2822 962 0
F +49 (0)2822 962 221
E sales@g-fittings.com